

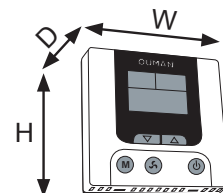

Technical information

Accuracy of measurement:	±0.5 °C
Measuring element:	NTC-10
Display:	LCD
Power supply:	24 VAC ±10%, 50 Hz / 60 Hz
Power consumption:	1 VA
Protection class:	IP 20 (dry conditions)
Dimensions:	H = 86 mm D = 23 mm W = 86 mm



TCR-10 is a smart room unit that has been developed to operate together with Ouman Plus home automation system. The room unit makes it possible to monitor and control the temperature of specific rooms and also change a room's "Normal temperature" setting. You can also use the room-specific unit to increase ventilation and change the home state control to "Night" and to "Home". A maximum number of Ouman TCR-10 room units is 8 and they can be connected to Ouman Plus.

Installation and connection of Ouman TCR-10

Phase 1

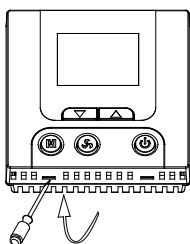

Open the Ouman TCR-10's rear panel with a screwdriver.

Phase 2

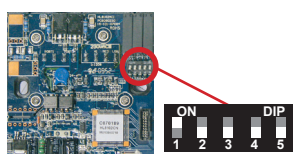

Flip the Dip switch 1 of the last TCR-10 on the bus to the ON position (= terminating resistor 120 Ω). Make this change even if there is only one room unit on the system.

Phase 3

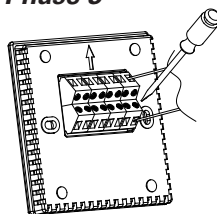

Make the necessary connections (see image 1 and 2).

Phase 4

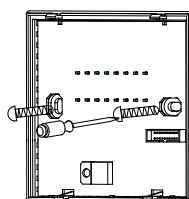

Attach the cover to the wall with screws.

Phase 5

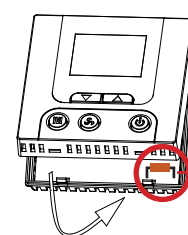

Press the front panel in place and proceed to phases 6 and 7. The sensor element must be perpendicular to the circuit board in relation to (avoid refraction). Refraction causes a measurement error!

Connection of Ouman TCR-10

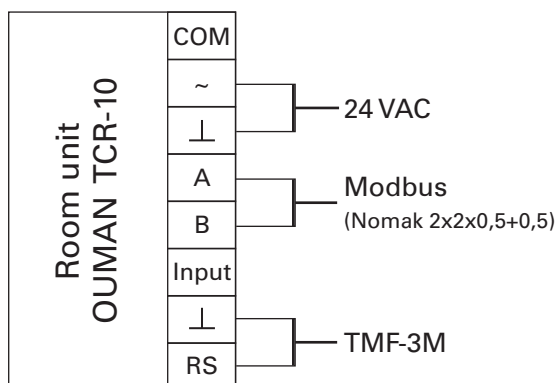

Connect Ouman TCR-10 to Ouman Plus centre's 24 VAC strip connectors to obtain operating voltage.

Connect TCR-10 to Ouman Plus's A1 and B1 Modbus connectors.

TMF-3M floor sensor connection to TCR-10. Ouman Plus system can utilize the floor sensor's measurement information to limit the temperature of the floor (minimum and maximum).

Image 1. Connection of Ouman TCR-10

Modbus connection of Ouman TCR-10

When you connect several TCR-10 units to Ouman Plus system, you must make the bus connection according to the diagram 2. Room-specific temperatures are controlled via the I/O expansion unit connected to Ouman Plus. Connect relay 1 (R1) of the I/O extension unit (= EH-686) so that it controls heating of the room whose room-specific Modbus address is 1. Using the same principle, connect Modbus addresses 2-8 to relays 2-8.

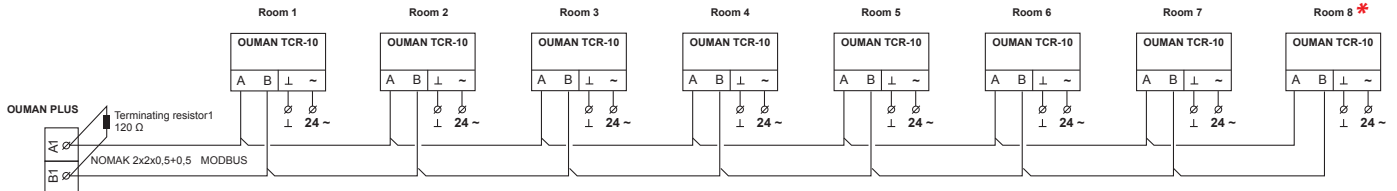

Image 2. Connection of Ouman TCR-10 to Ouman Plus system via Modbus.

***) Flip the Dip switch 1 of the last TCR-10 on the bus to the ON position (= terminating resistor 120 Ω). Make this change even if there is only one room-specific unit. See the image 2 on the top.**

Phase 6

Setting bus addresses for Ouman TCR-10

NOTE! Normally the bus addresses of the room units are set to at the factory (see label indicated on the packaging).



Image 3. OUMAN TCR-10 room unit is in programming mode.

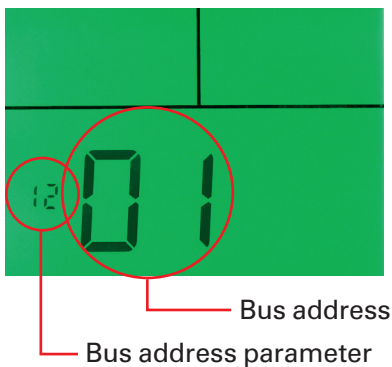

Image 4. OUMAN TCR-10 bus address setting.

Each Ouman TCR-10 room-specific unit must have its own bus address. If two or more bus devices have the same address, the bus connection will not work. Change bus addresses of room-specific units as follows:

Press the On/Off button (⏻) to turn off the power to the TCR-10 unit. Hold the (M) button down until the power is turned on. The unit is now in the programming mode and the display will look like image 3 on the left.

Press the (M) button so many times that the display looks like image 4 on the left. The bus address parameter's serial number is 12.

Use the (▼) and (▲) buttons to change the bus address.

When the bus address has been changed, the room-specific unit will automatically switch to a powerless state if the keyboard is not touched.

Press the (⏻) button to turn on the power to the room-specific unit.

Note! Follow the instructions carefully! Changing the wrong device parameter may cause the device to operate incorrectly.

Phase 7

User interface of Ouman TCR-10

The first time you press any button, only the display backlight will light up (settings will not change).



Changing room temperature settings

The TCR-10 room-specific unit can be used to change a room's "Normal temperature" setting. Press the or button to go to the setting's edit mode. Use the and buttons to change the setting. To change the room temperature settings "Small temperature drop" and "Big temperature drop" you need to go to Ouman Plus UI.

= automatic, ventilation control according to home state control

= ventilation boost 0.5 h

= ventilation boost 1.0 h

= ventilation boost 1.5 h

Ventilation boost

Press the ventilation boost button .

The symbol appearing in the display indicates in half-hour increments how much ventilation enhancement is left.

= night state control is active

Night state control

Press the button. A symbol indicating the "Night" state control will appear in the display. Press the button again to go from "Night" state control back to "Home" state control.



Room-specific big temperature drop

When you press the On/Off button to turn off the power to the room unit, the temperature level in that room will switch to "Big temperature drop" (specified in Ouman Plus).



Locking the unit

You can lock the keyboard so that you can not use the Ouman TCR-10 room-specific unit in question to make any changes. Press the and buttons at the same time for 10 seconds to alternately lock and unlock the keyboard.



Idle mode

The symbol appearing in the display indicates that room temperature is at the desired level.



The room unit requests more heat

If the symbol appears in the room-specific unit's display, the unit is requesting more heat from the heating controller.

